



# Evershine®



## Celebrating 25 Years of Trust and Excellence

- Kitchen Accessories
- Hardware Fitting
- Wardrobe Accessories
- Bathroom Accessories

—•—  
[www.evershinecrystal.in](http://www.evershinecrystal.in)

**Catalogue**  
01<sup>st</sup> August 2024



## Note

- All pictures shown are for illustration purpose only. Actual product may vary due to product enhancement.
- We reserve the right to change our product's prices at any time.



# Index

**03** Rolling Shutter

**06** Wicker Basket

**07** Larder Unit

**10** Corner Unit

**17** Smart Basket

**19** Waste Bin

**23** Bright Basket

**28** Wardrobe Accessories

**32** Hardware Products

**43** Aluminium Profile

**63** Bathroom Accessories



# Rolling Shutter



**Acrylic Rolling Shutter (Champagne)** HSN Code : 76169990  
Specification : GST % : 18 %

W X D X H

450 x 350 x 1400 mm  
600 x 350 x 1400 mm  
900 x 350 x 1400 mm



**Acrylic Rolling Shutter (Silver)** HSN Code : 76169990  
Specification : GST % : 18 %

W X D X H

450 x 350 x 1400 mm  
600 x 350 x 1400 mm  
900 x 350 x 1400 mm



**Acrylic Rolling Shutter (Black)** HSN Code : 76169990  
Specification : GST % : 18 %

W X D X H

450 x 350 x 1400 mm  
600 x 350 x 1400 mm  
900 x 350 x 1400 mm



**Acrylic Rolling Shutter (White)** HSN Code : 76169990  
Specification : GST % : 18 %

W X D X H

450 x 350 x 1400 mm  
600 x 350 x 1400 mm  
900 x 350 x 1400 mm



**Glass Rolling Shutter (Frosted)**  
Specification :

HSN Code : 76169990  
GST % : 18 %

**W X D X H**

450 x 350 x 1400 mm  
600 x 350 x 1400 mm  
900 x 350 x 1400 mm



**Glass Rolling Shutter (Black)**  
Specification :

HSN Code : 76169990  
GST % : 18 %

**W X D X H**

450 x 350 x 1400 mm  
600 x 350 x 1400 mm  
900 x 350 x 1400 mm



**Glass Rolling Shutter (White)**  
Specification :

HSN Code : 76169990  
GST % : 18 %

**W X D X H**

450 x 350 x 1400 mm  
600 x 350 x 1400 mm  
900 x 350 x 1400 mm

# Rolling Shutter



**PVC Rolling Shutter (Silver)**  
Specification :

HSN Code : 76169990  
GST % : 18 %

**W X D X H**

450 x 350 x 1400 mm  
600 x 350 x 1400 mm  
900 x 350 x 1400 mm



**PVC Rolling Shutter (Black)**  
Specification :

HSN Code : 76169990  
GST % : 18 %

**W X D X H**

450 x 350 x 1400 mm  
600 x 350 x 1400 mm  
900 x 350 x 1400 mm



**PVC Rolling Shutter (White)**  
Specification :

HSN Code : 76169990  
GST % : 18 %

**W X D X H**

450 x 350 x 1400 mm  
600 x 350 x 1400 mm  
900 x 350 x 1400 mm

GST - 5 % | HSN CODE - 46029000

## Wicker Basket Light Brown



### Size in mm

414 x 508 x 100  
414 x 508 x 150  
414 x 508 x 200  
564 x 508 x 100  
564 x 508 x 150  
564 x 508 x 200  
864 x 508 x 100  
864 x 508 x 150  
864 x 508 x 200

### Box Pack

-  
-  
-  
-  
-  
-  
-  
-  
-  
-

## Wicker Basket Dark Brown



### Size in mm

414 x 508 x 100  
414 x 508 x 150  
414 x 508 x 200  
564 x 508 x 100  
564 x 508 x 150  
564 x 508 x 200  
864 x 508 x 100  
864 x 508 x 150  
864 x 508 x 200

### Box Pack

-  
-  
-  
-  
-  
-  
-  
-  
-  
-

## Wicker Basket Light Brown - Soft Close



### Size in mm

414 x 508 x 100  
414 x 508 x 150  
414 x 508 x 200  
564 x 508 x 100  
564 x 508 x 150  
564 x 508 x 200  
864 x 508 x 100  
864 x 508 x 150  
864 x 508 x 200

### Box Pack

-  
-  
-  
-  
-  
-  
-  
-  
-

## Wicker Basket Dark Brown - Soft Close



### Size in mm

414 x 508 x 100  
414 x 508 x 150  
414 x 508 x 200  
564 x 508 x 100  
564 x 508 x 150  
564 x 508 x 200  
864 x 508 x 100  
864 x 508 x 150  
864 x 508 x 200

### Box Pack

-  
-  
-  
-  
-  
-  
-  
-  
-



# LARDER UNIT



GST - 12 % | HSN CODE - 73239990

## Tandem Pantry Unit - Glass - Soft Close



Size in mm (W x D x H)	Description	Carcass Width (mm)	Box Pack
380 x 510 x 1820	6 Layer	450 x 560 x 2020	01
380 x 510 x 1430	5 Layer	450 x 560 x 1920	01
380 x 510 x 1130	4 Layer	450 x 560 x 1320	01
480 x 510 x 1820	6 Layer	600 x 560 x 2020	01
480 x 510 x 1430	5 Layer	600 x 560 x 1920	01
480 x 510 x 1130	4 Layer	600 x 560 x 1320	01

## Tandem Pantry Unit - Premium - Soft Close



Size in mm (W x D x H)	Description	Carcass Width (mm)	Box Pack
<b>Single Strip</b>			
380 x 500 x 1820	6 Layer	450 x 560 x 2020	01
380 x 500 x 1430	5 Layer	450 x 560 x 1920	01
380 x 500 x 1130	4 Layer	450 x 560 x 1320	01
480 x 510 x 1820	6 Layer	600 x 560 x 2020	01
480 x 510 x 1430	5 Layer	600 x 560 x 1920	01
480 x 510 x 1130	4 Layer	600 x 560 x 1320	01
<b>Double Strip</b>			
380 x 500 x 1820	6 Layer	450 x 560 x 2020	01
380 x 500 x 1430	5 Layer	450 x 560 x 1920	01
380 x 500 x 1130	4 Layer	450 x 560 x 1320	01
480 x 510 x 1820	6 Layer	600 x 560 x 2020	01
480 x 510 x 1430	5 Layer	600 x 560 x 1920	01
480 x 510 x 1130	4 Layer	600 x 560 x 1320	01

Single Strip Double Strip

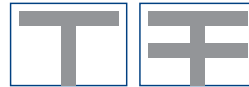

## Tandem Pantry Unit - Smart - Soft Close



Size in mm (W x D x H)	Description	Carcass Width (mm)	Box Pack
<b>Single Strip</b>			
380 x 500 x 1820	6 Layer	450 x 560 x 2020	01
380 x 500 x 1430	5 Layer	450 x 560 x 1920	01
380 x 500 x 1130	4 Layer	450 x 560 x 1320	01
480 x 510 x 1820	6 Layer	600 x 560 x 2020	01
480 x 510 x 1430	5 Layer	600 x 560 x 1920	01
480 x 510 x 1130	4 Layer	600 x 560 x 1320	01
<b>Double Strip</b>			
380 x 500 x 1820	6 Layer	450 x 560 x 2020	01
380 x 500 x 1430	5 Layer	450 x 560 x 1920	01
380 x 500 x 1130	4 Layer	450 x 560 x 1320	01
480 x 510 x 1820	6 Layer	600 x 560 x 2020	01
480 x 510 x 1430	5 Layer	600 x 560 x 1920	01
480 x 510 x 1130	4 Layer	600 x 560 x 1320	01

Single Strip Double Strip



# M.R.P. Price List

01st August 2024

GST - 12 % | HSN CODE - 73239990

Tandem Pantry Unit - Bright	Size in mm (W x D x H)	Description	Carcass Width (mm)	Box Pack
	485 x 510 x 1820	6 Layer	600 x 560 x 2020	01
	485 x 510 x 1430	5 Layer	600 x 560 x 1920	01
	485 x 510 x 1130	4 Layer	600 x 560 x 1320	01
	385 x 510 x 1820	6 Layer	450 x 560 x 2020	01
	385 x 510 x 1430	5 Layer	450 x 560 x 1920	01
	385 x 510 x 1130	4 Layer	450 x 560 x 1320	01

Vertical Pantry Unit - Premium	Size in mm (W x D x H)	Description	Carcass Width (mm)	Box Pack
	<b>Single Strip</b>			
	390 x 410 x 1820	6 Layer	450 x 560 x 2020	01
	390 x 410 x 1130	4 Layer	450 x 560 x 1320	01
	530 x 410 x 1820	6 Layer	600 x 560 x 2020	01
	530 x 410 x 1130	4 Layer	600 x 560 x 1320	01
	<b>Double Strip</b>			
	390 x 410 x 1820	6 Layer	450 x 560 x 2020	01
	390 x 410 x 1130	4 Layer	450 x 560 x 1320	01
	530 x 410 x 1820	6 Layer	600 x 560 x 2020	01
	530 x 410 x 1130	4 Layer	600 x 560 x 1320	01

Vertical Pantry Unit - Smart	Size in mm (W x D x H)	Description	Carcass Width (mm)	Box Pack
	<b>Single Strip</b>			
	390 x 410 x 1820	6 Layer	450 x 560 x 2020	01
	390 x 410 x 1130	4 Layer	450 x 560 x 1320	01
	530 x 410 x 1820	6 Layer	600 x 560 x 2020	01
	530 x 410 x 1130	4 Layer	600 x 560 x 1320	01
	<b>Double Strip</b>			
	390 x 410 x 1820	6 Layer	450 x 560 x 2020	01
	390 x 410 x 1130	4 Layer	450 x 560 x 1320	01
	530 x 410 x 1820	6 Layer	600 x 560 x 2020	01
	530 x 410 x 1130	4 Layer	600 x 560 x 1320	01

Vertical Double Pullout - Evershine	Size in mm (W x D x H)	Description	Carcass Width (mm)	Box Pack
	390 x 410 x 1785 - 2085	6 Layer	500 x 560 x 2020	01
	390 x 410 x 1385 - 1685	5 Layer	500 x 560 x 1650	01



# CORNER UNIT

# M.R.P. Price List

01<sup>st</sup> August 2024

GST - 12 % | HSN CODE - 73239990

## Swing Corner - Designer (Soft Close)



Size in mm (W x D x H)	Description	Carcass Width (mm)	Box Pack
815 x 400 x 650 - 800	2 Layer	1100 x 560 x 700	01
815 x 400 x 1250 - 1400	4 Layer	1100 x 560 x 1320	01

## Swing Corner - Premium (Soft Close)



Size in mm (W x D x H)	Description	Carcass Width (mm)	Box Pack
815 x 400 x 650 - 800	2 Layer	1100 x 560 x 700	01
815 x 400 x 1250 - 1400	4 Layer	1100 x 560 x 1320	01

## Swing Corner - Smart (Soft Close)



Size in mm (W x D x H)	Description	Carcass Width (mm)	Box Pack
815 x 400 x 650 - 800	2 Layer	1100 x 560 x 700	01
815 x 400 x 1250 - 1400	4 Layer	1100 x 560 x 1320	01

## Swing Corner - Deluxe (Soft Close)



Size in mm (W x D x H)	Description	Carcass Width (mm)	Box Pack
815 x 400 x 650 - 800	2 Layer	1100 x 560 x 700	01
815 x 400 x 1250 - 1400	4 Layer	1100 x 560 x 1320	01

GST - 12 % | HSN CODE - 73239990

## Magic Corner (Left / Right) - Glass (Soft Close)



Size in mm (W x D x H)	Carcass Width (mm)	Box Pack
860 x 530 x (530-750)	1100 x 560 x 700	01

## Magic Corner (Left / Right) - Premium (Soft Close)



Size in mm (W x D x H)	Description	Carcass Width (mm)	Box Pack
860 x 530 x (530-750)	1 Strip	1100 x 560 x 700	01
860 x 530 x (530-750)	2 Strip	1100 x 560 x 700	01

## Magic Corner (Left / Right) - Bright



Size in mm (W x D x H)	Carcass Width (mm)	Box Pack
860 x 530 x (530-750)	1100 x 560 x 700	02

## Magic Corner (Left / Right) - Smart (Soft Close)



Size in mm (W x D x H)	Carcass Width (mm)	Box Pack
860 x 530 x (530-750)(1 St.)	1100 x 560 x 700	01
860 x 530 x (530-750)(2 St.)	1100 x 560 x 700	01

## Magic Corner (Left / Right) - Evershine (Soft Close)



Size in mm (W x D x H)	Carcass Width (mm)	Box Pack
860 x 530 x (530-750)	1100 x 560 x 700	01

# M.R.P. Price List

01st August 2024

GST - 12 % | HSN CODE - 73239990

## Corner Organiser - Glass (Soft Close)



Size in mm (W x D x H)	Carcass Width (mm)	Box Pack
660 x 515 x 600	1100 x 560 x 700	01

## Corner Organiser- Premium (Soft Close)



Size in mm (W x D x H)	Description	Carcass Width (mm)	Box Pack
660 x 515 x 600	1 Strip	1100 x 560 x 700	01
660 x 515 x 600	2 Strip	1100 x 560 x 700	01

## Corner Organiser - Bright



Size in mm (W x D x H)	Carcass Width (mm)	Box Pack
660 x 515 x 600	---	02

## Corner Organiser - Smart (Soft Close)



Size in mm (W x D x H)	Carcass Width (mm)	Box Pack
660 x 515 x 600 (1 St.)	1100 x 560 x 700	01
660 x 515 x 600 (2 St.)	1100 x 560 x 700	01

## Corner Organiser - Evershine

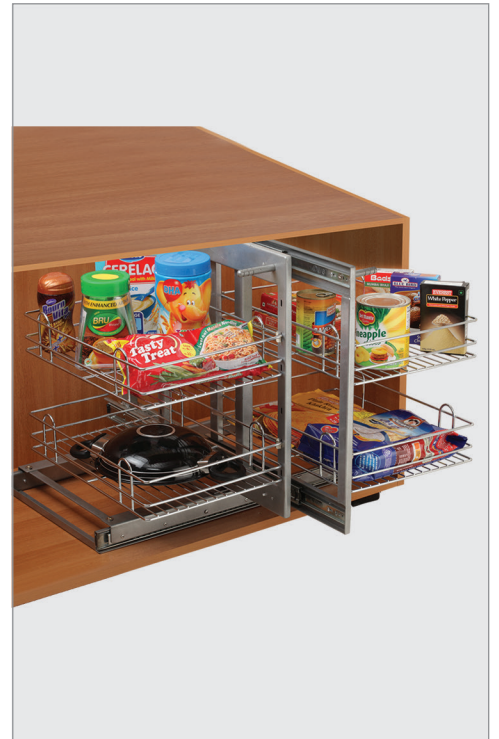

Size in mm (W x D x H)	Carcass Width (mm)	Box Pack
625 x 508 x 570	1100 x 560 x 700	02

GST - 12 % | HSN CODE - 73239990

## Carrousal Tray Without Pipe - Premium



Dia (mm)	Carcass Width (mm)	Box Pack
600, 700	900	02

## Carrousal Tray Without Pipe - Deluxe



Dia (mm)	Carcass Width (mm)	Box Pack
600, 700	900	02

## Carrousal Tray Without Pipe - Smart



Dia (mm)	Carcass Width (mm)	Box Pack
600, 700	900	02

## Carrousal Tray Without Pipe - Designer



Dia (mm)	Carcass Width (mm)	Box Pack
600, 700	900	02

**M.R.P. Price List**  
01st August 2024

**GST - 12 % | HSN CODE - 73239990**

**Carrousal Tray With Pipe - Premium**



Dia (mm)	Carcass Width (mm)	Box Pack
600, 700	900	02

**Carrousal Tray With Pipe - Deluxe**



Dia (mm)	Carcass Width (mm)	Box Pack
600, 700	900	02

**Carrousal Tray With Pipe - Smart**



Dia (mm)	Carcass Width (mm)	Box Pack
600, 700	900	02

**Carrousal Tray With Pipe - Designer**



Dia (mm)	Carcass Width (mm)	Box Pack
600, 700	900	02

**Carrousal Tray With Pipe - Evershine**



Dia (mm)	Carcass Width (mm)	Box Pack
600, 700	900	02



GST - 12 % | HSN CODE - 73239990

## Dee Tray - Premium



Dia (mm)	Carcass Width (mm)	Box Pack
600, 700	900	02

## Dee Tray - Deluxe



Dia (mm)	Carcass Width (mm)	Box Pack
600, 700	900	02

## Dee Tray - Smart



Dia (mm)	Carcass Width (mm)	Box Pack
600, 700	900	02

## Dee Tray - Designer



Dia (mm)	Carcass Width (mm)	Box Pack
600, 700	900	02

## Dee Tray - Evershine



Dia (mm)	Carcass Width (mm)	Box Pack
600, 700	900	02



# KITCHEN PULLOUT

**Evershine**<sup>®</sup>  
*Innovative Kitchen Solution* **SMART**

GST - 12 % | HSN CODE - 73239990

**M.P Single Pullout - Glass (Soft Close)**



Size in Inch	Size in mm	Box Pack
<b>2 Layer - Universal</b>		
-	160 x 485 x 485	3
-	210 x 485 x 485	3
-	260 x 485 x 485	3

Size in Inch	Size in mm	Box Pack
<b>3 Layer - Universal</b>		
-	160 x 485 x 585	3
-	210 x 485 x 585	3
-	260 x 485 x 585	3

**M.P.Single Pullout**



Size in Inch	Size in mm	Box Pack
5 x 20 x 24	125 x 485 x 610	3
7 x 20 x 24	175 x 485 x 610	3
9 x 20 x 24	225 x 485 x 610	3

Size in Inch	Size in mm	Box Pack
5 x 22 x 24	125 x 535 x 610	3
7 x 22 x 24	175 x 535 x 610	3
9 x 22 x 24	225 x 535 x 610	3

**Bottle Plate Pullout**



Size in Inch	Size in mm	Box Pack
12 x 20 x 17	300 x 485 x 430	2

**Two Shelf Pullout**



Size in Inch	Size in mm	Box Pack
6 x 20 x 17	150 x 485 x 430	4
8 x 20 x 17	200 x 485 x 430	3
12 x 20 x 17	300 x 485 x 430	2

**Three Shelf Pullout**



Size in Inch	Size in mm	Box Pack
6 x 20 x 21	150 x 485 x 530	4
8 x 20 x 21	200 x 485 x 530	3
12 x 20 x 21	300 x 485 x 530	2



# WASTE BIN

Dustbin Square - Imported	HSN Code	GST %	Width x Depth (mm)	Height (mm)	Box Pack
	39269099	18%	340 x 510	430 (20 LTR)	2
Dustbin PVC	HSN Code	GST %	Description		Box Pack
	39269099	18%	Capacity 10 Litre (W-270mm x H-335mm)		4
Dustbin SS	HSN Code	GST %	Description		Box Pack
	73242900	18%	Capacity 10 Litre (W-270mm x H-335mm)		4
Waste Bin - 6 (Revolving)	HSN Code	GST %	Description (Size in mm)		Box Pack
	39269099	18%	2 Bin 10+10 Litre (W-270 x H-335)		-
Dust Bin - A	HSN Code	GST %	Description (Size in mm)		Box Pack
	39269099	18%	Capacity 20 Litre (W-235 x D-305 x H-375)		-
Dust Bin - B	HSN Code	GST %	Description (Size in mm)		Box Pack
	39269099	18%	Capacity 10 Litre (Dia-250 x H-290)		-

# M.R.P. Price List

01st August 2024

Waste Bin - 2A (With Soft Close)	HSN Code	GST %	Description (Size in mm)	Box Pack
	39269099	18%	2 Bin 20+20 Litre (W-362 x D-510 x H-400)	-
Waste Bin - 2B (With Soft Close)	HSN Code	GST %	Description (Size in mm)	Box Pack
	39269099	18%	3 Bin 20+10+10 Litre (W-362 x D-510 x H-400)	-
Waste Bin - 2C (With Soft Close)	HSN Code	GST %	Description (Size in mm)	Box Pack
	39269099	18%	4 Bin 10+10+10+10 Litre (W-362 x D-510 x H-400)	-
Waste Bin - 3A (With Soft Close)	HSN Code	GST %	Description (Size in mm)	Box Pack
	39269099	18%	2 Bin 20+10 Litre (W-292 x D-510 x H-400)	-

Waste Bin - 3B (With Soft Close)	HSN Code	GST %	Description (Size in mm)	Box Pack
	39269099	18%	3 Bin 10+10+10 Litre (W-292 x D-510 x H-400)	-
Waste Bin - 4 (With Soft Close)	HSN Code	GST %	Description (Size in mm)	Box Pack
	39269099	18%	2 Bin 10+10 Litre (W-214 x D-510 x H-400)	-
Waste Bin - 5A (With Soft Close)	HSN Code	GST %	Description (Size in mm)	Box Pack
	39269099	18%	1 Bin 20 Litre (W-292 x D-367 x H-400)	-
Waste Bin - 5B (With Soft Close)	HSN Code	GST %	Description (Size in mm)	Box Pack
	39269099	18%	2 Bin 10+10 Litre (W-292 x D-367 x H-400)	-





**BRIGHT  
BASKET**

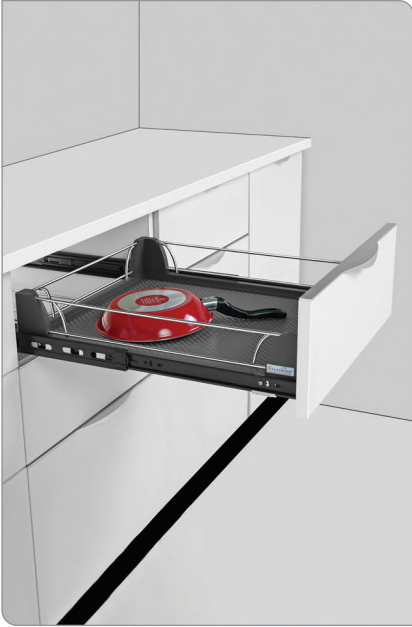

**Telescopic Slide Base**

M.R.P. Given Is Without Telescopic Slides



Plain Basket	HSN Code	GST %	Size in Inch	Size in mm	Box Pack
	76151030	12%	15 x 16 x 4	375 x 400 x 100	6
			15 x 16 x 6	375 x 400 x 150	4
			15 x 16 x 8	375 x 400 x 200	3
	76151030	12%	12 x 20 x 4	300 x 500 x 100	6
			12 x 20 x 6	300 x 500 x 150	4
			12 x 20 x 8	300 x 500 x 200	3
			15 x 20 x 4	375 x 500 x 100	6
			15 x 20 x 6	375 x 500 x 150	4
			15 x 20 x 8	375 x 500 x 200	3
			17 x 20 x 4	425 x 500 x 100	6
			17 x 20 x 6	425 x 500 x 150	4
			17 x 20 x 8	425 x 500 x 200	3
			19 x 20 x 4	475 x 500 x 100	6
			19 x 20 x 6	475 x 500 x 150	4
			19 x 20 x 8	475 x 500 x 200	3
	76151030	12%	12 x 22 x 4	300 x 550 x 100	6
			12 x 22 x 6	300 x 550 x 150	4
			12 x 22 x 8	300 x 550 x 200	3
			15 x 22 x 4	375 x 550 x 100	6
			15 x 22 x 6	375 x 550 x 150	4
			15 x 22 x 8	375 x 550 x 200	3
			17 x 22 x 4	425 x 550 x 100	6
			17 x 22 x 6	425 x 550 x 150	4
			17 x 22 x 8	425 x 550 x 200	3
			19 x 22 x 4	475 x 550 x 100	6
			19 x 22 x 6	475 x 550 x 150	4
			19 x 22 x 8	475 x 550 x 200	3
			21 x 22 x 4	525 x 550 x 100	6
			21 x 22 x 6	525 x 550 x 150	4
			21 x 22 x 8	525 x 550 x 200	3

# M.R.P. Price List

01st August 2024

## Under Mount Slides

M.R.P. Given Is Without Under Mount Slides





Plain Basket	HSN Code	GST %	Size in Inch	Size in mm	Box Pack
	76151030	12%	15 x 16 x 4	380 x 405 x 100	6
			15 x 16 x 6	380 x 405 x 150	4
			15 x 16 x 8	380 x 405 x 200	3
	76151030	12%	12 x 20 x 4	304 x 500 x 100	6
			12 x 20 x 6	304 x 500 x 150	4
			12 x 20 x 8	304 x 500 x 200	3
			15 x 20 x 4	380 x 500 x 100	6
			15 x 20 x 6	380 x 500 x 150	4
			15 x 20 x 8	380 x 500 x 200	3
			17 x 20 x 4	430 x 500 x 100	6
			17 x 20 x 6	430 x 500 x 150	4
			17 x 20 x 8	430 x 500 x 200	3
			19 x 20 x 4	480 x 500 x 100	6
			19 x 20 x 6	480 x 500 x 150	4
			19 x 20 x 8	480 x 500 x 200	3
	76151030	12%	12 x 22 x 4	304 x 550 x 100	6
			12 x 22 x 6	304 x 550 x 150	4
			12 x 22 x 8	304 x 550 x 200	3
			15 x 22 x 4	380 x 550 x 100	6
			15 x 22 x 6	380 x 550 x 150	4
			15 x 22 x 8	380 x 550 x 200	3
			17 x 22 x 4	430 x 550 x 100	6
			17 x 22 x 6	430 x 550 x 150	4
			17 x 22 x 8	430 x 550 x 200	3
			19 x 22 x 4	480 x 550 x 100	6
			19 x 22 x 6	480 x 550 x 100	4
			19 x 22 x 8	480 x 550 x 150	3
			21 x 22 x 4	530 x 550 x 100	6
			21 x 22 x 6	530 x 550 x 150	4
			21 x 22 x 8	530 x 550 x 200	3

Drawer Slide (Soft Close) For Bright Basket	HSN Code	GST %	Size in Inch	Size in mm	Box Pack
	83024200	18%	12	300	10
			14	350	10
			16	400	10
			18	450	10
			20	500	10
			22	550	10

M.P.Single Pullout - Soft close - Universal	HSN Code	GST %	Size in Inch	Size in mm	Box Pack
	<b>2 Layer</b>				
	73239990	12%	-	160 x 485 x 485	3
			-	210 x 485 x 485	3
			-	260 x 485 x 485	3
			-	310 x 485 x 485	3
	<b>3 Layer</b>				
	73239990	12%	-	160 x 485 x 585	3
			-	210 x 485 x 585	3
			-	260 x 485 x 585	3
			-	310 x 485 x 585	3

# M.R.P. Price List

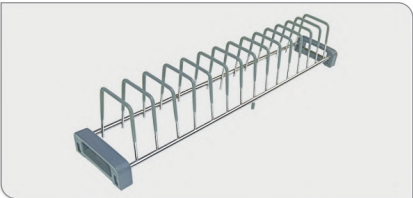
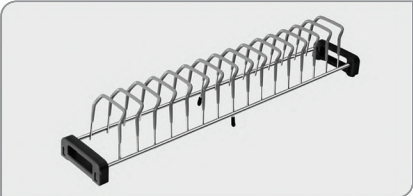
01<sup>st</sup> August 2024

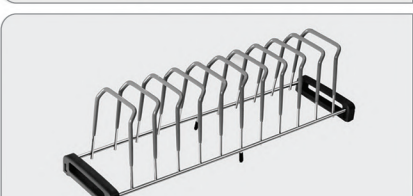
Cup & Saucer Partition - PVC	HSN Code	GST %	Size in Inch	Size in mm	Box Pack
	39249090	18%	20 x 4 22 x 4	475 x 100 525 x 100	- -
Thali - Plate Partition - PVC	HSN Code	GST %	Size in Inch	Size in mm	Box Pack
	39249090	18%	20 x 6 22 x 6	475 x 150 525 x 150	- -
Cup & Saucer Partition S.S. Rod with Soft PVC	HSN Code	GST %	Size in Inch	Size in mm	Box Pack
	<b>Straight Type</b>				
	73239990	12%	20 x 4 22 x 4	475 x 100 525 x 100	- -
	<b>Bend Type</b>				
	73239990	12%	20 x 4 22 x 4	475 x 100 525 x 100	- -
Thali-Plate Partition S.S. Rod with Soft PVC	HSN Code	GST %	Size in Inch	Size in mm	Box Pack
	<b>Straight Type</b>				
	73239990	12%	20 x 6 22 x 6	475 x 150 525 x 150	- -
	<b>Bend Type</b>				
	73239990	12%	20 x 6 22 x 6	475 x 150 525 x 150	- -



# **WARDROBE ACCESSORIES**

**M.R.P. Price List**  
01<sup>st</sup> August 2024

GST - 18 % | HSN CODE - 76169990

**Garnishry Box**



**Size in mm**  
(W x D x H)

564 x 475 x 85  
864 x 475 x 100

**Trouser & Clothes Rack**



**Size in mm**  
(W x D x H)

564 x 475 x 100  
864 x 475 x 95

**Clothes Rack - S.S.**



**Size in mm**  
(W x D x H)

564 x 475 x 100  
864 x 475 x 160

**Clothes Rack - PVC**



**Size in mm**  
(W x D x H)

564 x 475 x 95  
864 x 475 x 95

**Clothes Basket**



**Size in mm**  
(W x D x H)

564 x 475 x 200  
864 x 475 x 200

**Trouser Rack New**



**Size in mm**  
(W x D x H)

564 x 475 x 72  
864 x 475 x 72

**Up - Down Rack (Soft Close)**



**Size in mm**  
(W x D x H)

760-1240 x 355 x 740

**Trouser Rack**



**Size in mm**  
(W x D x H)

710 x 508 x 60  
810 x 508 x 60

**Belt Rack**



**Size in mm**  
(W x D x H)

300

GST - 18 % | HSN CODE - 73269099

## Sliding Hanger Holder - 11 Hook



Size in mm  
(W x D x H)

365 x 480 x 120

## Iron Rack



Size in mm  
(W x D x H)

265 x 435 x 145

## Sliding Hanger Holder



Size in mm  
(W x D x H)

35 x 508 x 150

## Trouser Slider - Regular



Size in mm  
(W x D x H)

370 x 508 x 175

## Trouser Slider - Sleek



Size in mm  
(W x D x H)

370 x 508 x 175

## Tie Slider - Regular



Size in mm  
(W x D x H)

150 x 508 x 60

## Perfume Rack - Wooden Base



Size in mm  
(W x D x H)

300 x 100 x 100  
405 x 100 x 100

## Perfume Rack - Wire Base



Size in mm  
(W x D x H)

300 x 100 x 100  
405 x 100 x 100

## Hook Liner

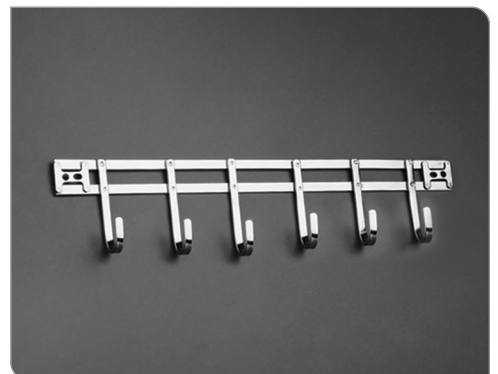

-

4 Hook  
6 Hook  
8 Hook

GST - 18 % | HSN CODE - 73269099

Hook Liner - Regular

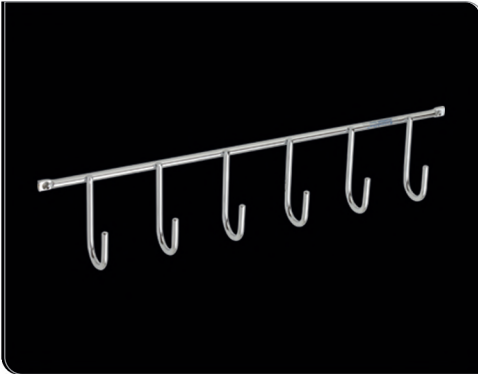

-

4 Hook  
6 Hook  
8 Hook

Cloth Hanger



-

-

Cloth Hanger - Wire

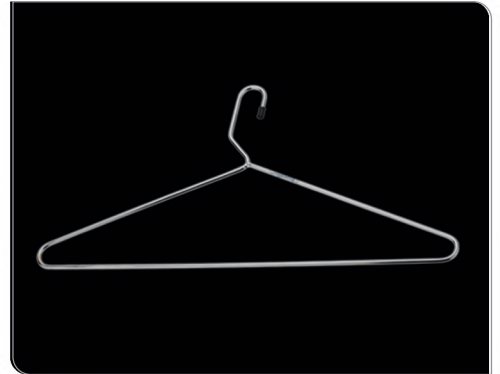

Size in mm  
(W x D x H)

-

Shoes Rack (Adustable)



Size in mm  
(W x D x H)

500 x 360 x 1060 - 4 Layer  
Cabinet Width = 600  
500 x 360 x 1340 - 6 Layer  
Cabinet Width = 600  
500 x 360 x 1620 - 8 Layer  
Cabinet Width = 600  
500 x 360 x 1900 - 10 Layer  
Cabinet Width = 600  
500 x 360 x 2180 - 12 Layer  
Cabinet Width = 600  
800 x 360 x 1060 - 4 Layer  
Cabinet Width = 900  
800 x 360 x 1340 - 6 Layer  
Cabinet Width = 900  
800 x 360 x 1620 - 8 Layer  
Cabinet Width = 900  
800 x 360 x 1900 - 10 Layer  
Cabinet Width = 900  
800 x 360 x 2180 - 12 Layer  
Cabinet Width = 900

Oval Pipe



Size in mm  
(W x D x H)

35 x 15 x 900  
35 x 15 x 1200

Oval Pipe Holder



Size in mm  
(W x D x H)

-







**HARDWARE  
PRODUCTS**

# M.R.P. Price List

01<sup>st</sup> August 2024

Slimbox Drawer System	HSN Code	GST %	Size in Inch	Size in mm	Box Pack
	83024200	18%	12 x 4 12 x 6 12 x 8	300 x 88 300 x 120 300 x 184	06 Set 04 Set 04 Set
	83024200	18%	14 x 4 14 x 6 14 x 8	350 x 88 350 x 120 350 x 184	06 Set 04 Set 04 Set
	83024200	18%	16 x 4 16 x 6 16 x 8	400 x 88 400 x 120 400 x 184	06 Set 04 Set 04 Set
	83024200	18%	18 x 4 18 x 6 18 x 8	450 x 88 450 x 120 450 x 184	06 Set 04 Set 04 Set
	83024200	18%	20 x 4 20 x 6 20 x 8	500 x 88 500 x 120 500 x 184	06 Set 04 Set 04 Set
	83024200	18%	22 x 4 22 x 6 22 x 8	550 x 88 550 x 120 550 x 184	06 Set 04 Set 04 Set
	83024200	18%	24 x 4 24 x 6 24 x 8	600 x 88 600 x 120 600 x 184	06 Set 04 Set 04 Set
Slimbox Drawer Front Panel	HSN Code	GST %	Size in Inch	Size in mm	Box Pack
	83024200	18%	- -	107 x 1000 Kit For 107	25 Set 50 Set
	83024200	18%	- -	140 x 1000 Kit For 140	25 Set 50 Set
Square Gallery Rails	HSN Code	GST %	Size in Inch	Size in mm	Box Pack
	83024200	18%	12	300	25 Set
			14	350	25 Set
			16	400	25 Set
			18	450	25 Set
			20	500	25 Set
			22	550	25 Set
			24	600	25 Set
Folding RCB For Slimbox Gallery	HSN Code	GST %	Size in Inch	Size in mm	Box Pack
	83024200	18%	-	-	-

Tandem Uni Box - Dark Grey	HSN Code	GST %	Size in Inch	Size in mm	Box Pack
	83024200	18%	12 x 4	300	6
			14 x 4	350	6
			16 x 4	400	6
			18 x 4	450	6
			20 x 4	500	6
			22 x 4	550	6
			24 x 4	600	6



Tandem Uni Box - RCB - Dark Grey	HSN Code	GST %	Size in Inch	Size in mm	Box Pack
	83024200	18%	-	76	-
			-	128	-
			-	146	-
			-	206	-
			-	-	-

Tandem Uni Box - Square - Gallery Rail - Dark Grey	HSN Code	GST %	Size in Inch	Size in mm	Box Pack
	83024200	18%	12"	300	-
			14"	350	-
			16"	400	-
			18"	450	-
			20"	500	-
			22"	550	-
			24"	600	-

Tandem Uni Box - Square - Gallery Rail - Middle - Dark Grey	HSN Code	GST %	Size in Inch	Size in mm	Box Pack
	83024200	18%	12"	300	-
			14"	350	-
			16"	400	-
			18"	450	-
			20"	500	-
			22"	550	-
			24"	600	-



# M.R.P. Price List

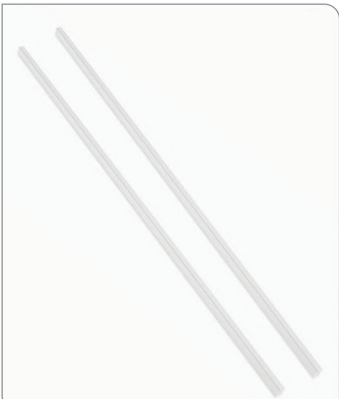

01st August 2024

Tandem Uni Box - White	HSN Code	GST %	Size in Inch	Size in mm	Box Pack
	83024200	18%	12 x 4	300	6
			14 x 4	350	6
			16 x 4	400	6
			18 x 4	450	6
			20 x 4	500	6
			22 x 4	550	6
			24 x 4	600	6
Tandem Uni Box - RCB - White	HSN Code	GST %	Size in Inch	Size in mm	Box Pack
	83024200	18%	-	76	-
			-	128	-
			-	146	-
			-	206	-
Tandem Uni Box - Square - Gallery Rail - White	HSN Code	GST %	Size in Inch	Size in mm	Box Pack
	83024200	18%	12"	300	-
			14"	350	-
			16"	400	-
			18"	450	-
			20"	500	-
			22"	550	-
			24"	600	-
Tandem Uni Box - Square - Gallery Rail - Middle - White	HSN Code	GST %	Size in Inch	Size in mm	Box Pack
	83024200	18%	12"	300	-
			14"	350	-
			16"	400	-
			18"	450	-
			20"	500	-
			22"	550	-
			24"	600	-

S.S. - Telescopic Channel	HSN Code	GST %	Size in Inch	Size in mm	Box Pack
	83024200	18%	10	250	10 Set
			12	300	10 Set
			14	350	10 Set
			16	400	10 Set
			18	450	10 Set
			20	500	10 Set
			22	550	10 Set

Soft Close - Telescopic Channel	HSN Code	GST %	Size in Inch	Size in mm	Box Pack
	83024200	18%	12	300	10 Set
			14	350	10 Set
			16	400	10 Set
			18	450	10 Set
			20	500	10 Set
			22	550	10 Set
			24	600	10 Set

Telescopic Channel Gold	HSN Code	GST %	Size in Inch	Size in mm	Box Pack
 <p>Zinc</p>	83024200	18%	10	250	10 Set
			12	300	10 Set
14			350	10 Set	
16			400	10 Set	
18			450	10 Set	
 <p>Black</p>			20	500	10 Set
			22	550	10 Set
			24	600	10 Set
			30	750	10 Set
			36	900	10 Set

Telescopic Channel Silver	HSN Code	GST %	Size in Inch	Size in mm	Box Pack
 <p>Zinc</p>	83024200	18%	8	200	15 Set
			10	250	15 Set
12			300	15 Set	
14			350	15 Set	
16			400	15 Set	
 <p>Black</p>			18	450	15 Set
			20	500	15 Set
			22	550	15 Set
			24	600	15 Set
			30	750	15 Set
			36	900	15 Set

# M.R.P. Price List





01<sup>st</sup> August 2024

Copper Finish Soft Close Clip on Hinges	HSN Code	GST %	Product Description	Box Pack
	83021090	18%	0 Degree - Full Overlay 8 Degree - Half Overlay 15 Degree - Insert	50 set 50 set 50 set
S.S. Regular Clip on Hinges	HSN Code	GST %	Product Description	Box Pack
	83021090	18%	0 Degree - Full Overlay 8 Degree - Half Overlay 15 Degree - Insert	50 set 50 set 50 set
S.S. Soft Close Clip on Hinges	HSN Code	GST %	Product Description	Box Pack
	83021090	18%	0 Degree - Full Overlay 8 Degree - Half Overlay 15 Degree - Insert	50 set 50 set 50 set
Regular Hinges	HSN Code	GST %	Product Description	Box Pack
	83021090	18%	0 Degree - Full Overlay 8 Degree - Half Overlay 15 Degree - Insert 135 Degree	50 set 50 set 50 set 50 set
Soft Close Hinges	HSN Code	GST %	Product Description	Box Pack
	83021090	18%	0 Degree - Full Overlay 8 Degree - Half Overlay 15 Degree - Insert	50 set 50 set 50 set
3D-Soft Close Clip on Hinges	HSN Code	GST %	Product Description	Box Pack
	83021090	18%	0 Degree - Full Overlay 8 Degree - Half Overlay 15 Degree - Insert 165 Degree - 0 crank	50 set 50 set 50 set 50 set

Cassetto Slide	HSN Code	GST %	Size in Inch	Size in mm	Box Pack
	83024200	18%	12 14 16 18 20 22 24	300 350 400 450 500 550 600	10 Set 10 Set 10 Set 10 Set 10 Set 10 Set 10 Set
Gas Pump	HSN Code	GST %	Size in Kg.		Box Pack
	83024200	18%	5 10 15 20 25 30		20 Set 20 Set 20 Set 20 Set 20 Set 20 Set
Gas Pump - 12 inch	HSN Code	GST %	Size in Kg.		Box Pack
	83024200	18%	5 10 15 20 25 30 35		20 Set 20 Set 20 Set 20 Set 20 Set 20 Set 20 Set
Gas Pump Soft Close - 9 inch	HSN Code	GST %	Size in Kg.		Box Pack
	83024200	18%	5 10 15 20 25 30		20 Set 20 Set 20 Set 20 Set 20 Set 20 Set
Bed Fitting	HSN Code	GST %	Size in Feet		Box Pack
	94031010	18%	03 04 05		- - -
Gas Spring For Bed Fitting	HSN Code	GST %	Size in Kg.		Box Pack
	73209090	18%	50 75 100 125 150 175 200		Set Set Set Set Set Set Set

# M.R.P. Price List

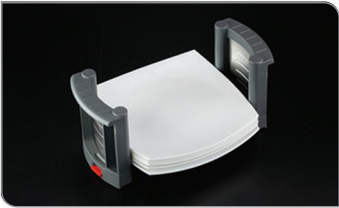

01st August 2024

Elevator Pull Down (Glass Basket)	HSN Code	GST %	Carcass Size	Width (mm)	Box Pack
	73239990	12%	600 900	560 - 564 860 - 864	1 1
Adjustable Plate Holder SS	HSN Code	GST %	Width x Depth (mm)	Height (mm)	Box Pack
	73242900	18%	-	-	-
Adjustable Plate Holder - PVC	HSN Code	GST %	Width x Depth (mm)	Height (mm)	Box Pack
	39269099	18%	-	-	-
Cutlery Tray (PVC) - Grey	HSN Code	GST %	Width (mm)	Depth (mm)	Box Pack
	39269099	18%	335 385 430 530 630 730 830	485 485 485 485 485 485 485	- - - - - - -
Adjustable Cutlery Tray - Aluminum	HSN Code	GST %	Cabinet Width (mm)	Size in mm	Box Pack
	76151030	12%	400	323 x 474 x 60	-
			450	373 x 474 x 60	-
			500	423 x 474 x 60	-
			550	473 x 474 x 60	-
			600	523 x 474 x 60	-
			650	573 x 474 x 60	-
			700	623 x 474 x 60	-
			750	673 x 474 x 60	-
			800	723 x 474 x 60	-
			850	773 x 474 x 60	-
			900	823 x 474 x 60	-
			400	323 x 524 x 60	-
			450	373 x 524 x 60	-
			500	423 x 524 x 60	-
550	473 x 524 x 60	-			
600	523 x 524 x 60	-			
650	573 x 524 x 60	-			
700	623 x 524 x 60	-			
750	673 x 524 x 60	-			
800	723 x 524 x 60	-			
850	773 x 524 x 60	-			
900	823 x 524 x 60	-			

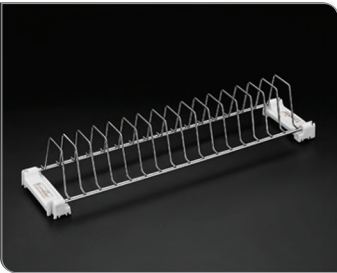
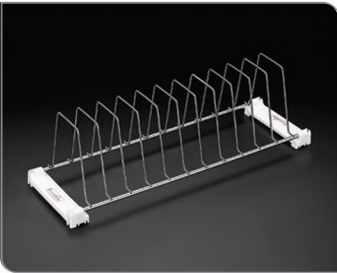
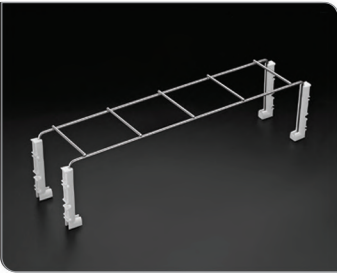

Cassette Slide Strip for Alluminum basket	HSN Code	GST %	Size in Inch	Size in mm	Box Pack
	83024200	18%	12"	300	-
			14"	350	-
			16"	400	-
			18"	450	-
			20"	500	-
			22"	550	-
			24"	600	-
Clamp (For Wooden Drawer)	HSN Code	GST %	Size in Inch	Size in mm	Box Pack
	39269099	18%	-	-	02 pcs
Plastic Bracket (For Wire Basket)	HSN Code	GST %	Size in Inch	Size in mm	Box Pack
	39269099	18%	Big New	- -	04 pcs 04 pcs
Skirting (Black & Silver)	HSN Code	GST %	Description		Box Pack
	39249090	18%	Skirting Black - 100 mm - 3 Mtr Skirting Silver - 100 mm - 3 Mtr		- -
Skirting Corner & Connector	HSN Code	GST %	Description		Box Pack
	39249090	18%	90° Corner - Black H-100mm 90° Corner - Silver H-100mm 180° Corner - Black H-100mm 180° Corner - Silver H-100mm		- - - -

**M.R.P. Price List**  
01<sup>st</sup> August 2024

Cup & Saucer Stand	HSN Code	GST %	Size in Inch	Size in mm	Box Pack
	73239990	12%	16 x 4 20 x 4 22 x 4	385 x 100 485 x 100 535 x 100	- - -
Thali - Plate Stand	HSN Code	GST %	Size in Inch	Size in mm	Box Pack
	73239990	12%	16 x 6 20 x 6 22 x 6	385 x 150 485 x 150 535 x 150	- - -
Bottle Stand	HSN Code	GST %	Size in Inch	Size in mm	Box Pack
	73239990	12%	16 x 6 20 x 6 22 x 6	385 x 150 485 x 150 535 x 150	- - -
Glass Stand	HSN Code	GST %	Size in Inch	Size in mm	Box Pack
	73239990	12%	16 x 4 20 x 4 22 x 4	385 x 100 485 x 100 535 x 100	- - -
Basket Stand	HSN Code	GST %	Size in Inch	Size in mm	Box Pack
	73239990	12%	16 x 4 16 x 6 16 x 8	385 x 100 385 x 150 385 x 200	- - -
	73239990	12%	20 x 4 20 x 6 20 x 8	485 x 100 485 x 150 485 x 200	- - -
	73239990	12%	22 x 4 22 x 6 22 x 8	535 x 100 535 x 150 535 x 200	- - -

GST - 18 % | HSN CODE - 39249090

## Cabinet Carcass Leg (Triangle-01)



Size in mm	Box Pack
Triangle 100 mm	150
Triangle 150 mm	130

## Cabinet Carcass Leg (Round-01)



Size in mm	Box Pack
Round 100 mm	400
Round 150 mm	300

## Cabinet Carcass Leg (Triangle-02)



Size in mm	Box Pack
Triangle 75 mm	150
Triangle 100 mm	150
Triangle 150 mm	130

## Cabinet Carcass Leg (Round-02)



Size in mm	Box Pack
Round 75 mm	400
Round 100 mm	400
Round 150 mm	300

## Skirting Clip



Size in mm	Box Pack
Skirting Clip	-

## Door Stiffener



Description	Box Pack
Door Stiffener Kit L-1900mm	-
Door Stiffener Kit L-2800mm	-

## Concealed Hanging Bracket for Wall Cabinet

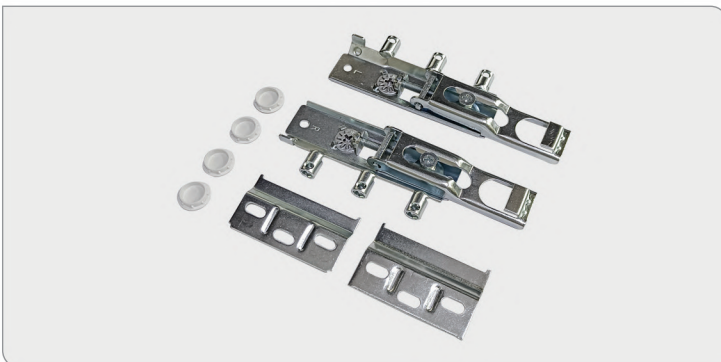

HSN Code	GST %	Description	Box Pack
83024200	18%	Weight Capacity 60kg. Finish - Zinc	-

## Hanging Bracket for Wall Cabinet

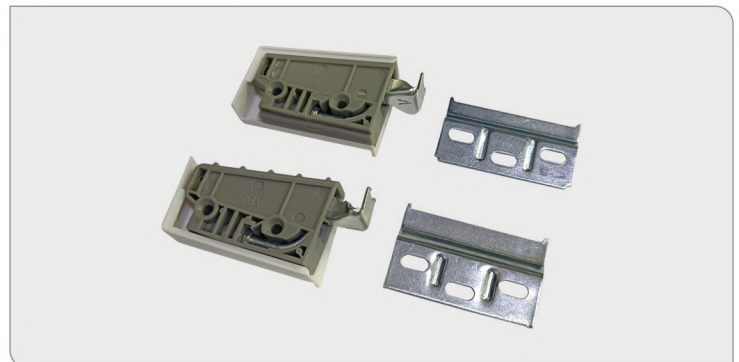

HSN Code	GST %	Description	Box Pack
83024200	18%	Weight Capacity 60kg. Finish - Zinc & White	-



# ALUMINIUM PROFILE

# Aluminium

## Frame Profile

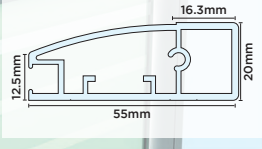
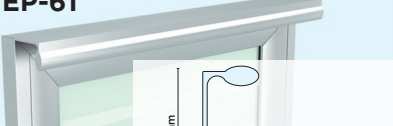
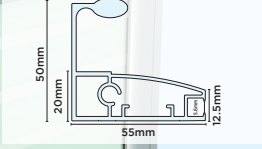
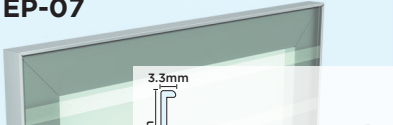
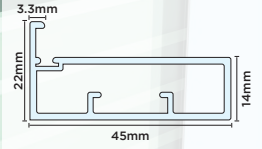
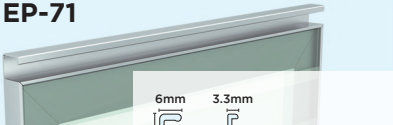
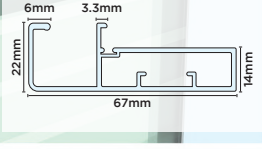
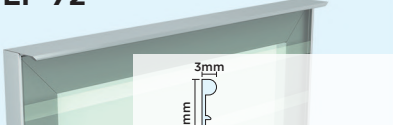
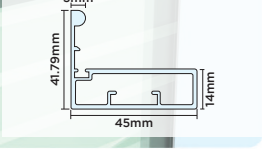
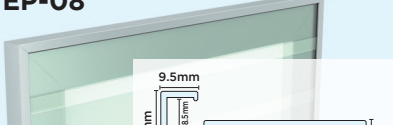
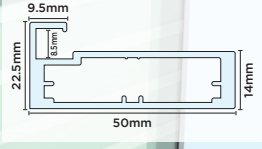
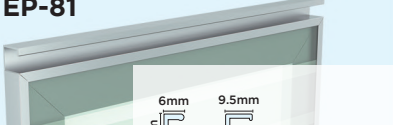
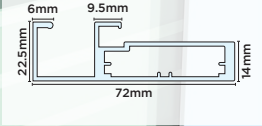
Sr.	Frame Profile	Finish	Ply Thickness	Glass Thickness	HSN Code	GST %	Box Pack
01	<b>EP-06</b> 	Anodized	-	4 - 5 mm	76109030	18%	11
02		SS Brush	-	-	-	-	-
01	<b>EP-61</b> 	Anodized	-	4 - 5 mm	76109030	18%	11
02		SS Brush	-	-	-	-	-
01	<b>EP-07</b> 	Anodized	-	5 mm	76109030	18%	11
02		SS Brush	-	5 mm	76109030	18%	11
01	<b>EP-71</b> 	Anodized	-	5 mm	76109030	18%	11
02		SS Brush	-	5 mm	76109030	18%	11
01	<b>EP-72</b> 	Anodized	-	5 mm	76109030	18%	11
02		SS Brush	-	5 mm	76109030	18%	11
01	<b>EP-08</b> 	Anodized	-	6 mm	76109030	18%	11
02		SS Brush	-	6 mm	76109030	18%	11
01	<b>EP-81</b> 	Anodized	-	6 mm	76109030	18%	11
02		SS Brush	-	6 mm	76109030	18%	11

# M.R.P. Price List

01st August 2024

# Aluminium Frame Profile

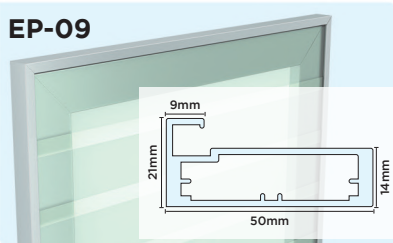
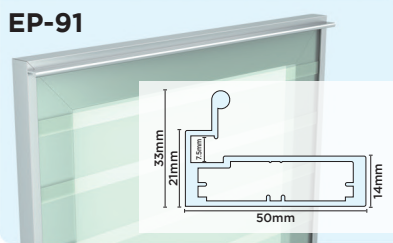
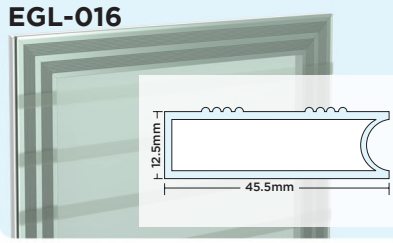
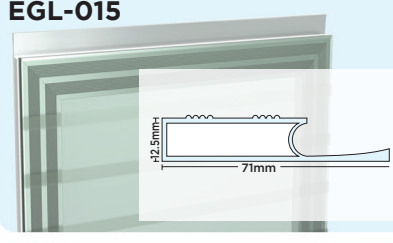
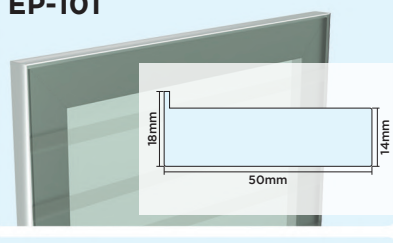
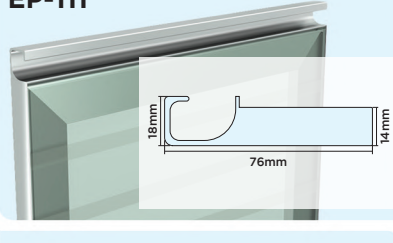
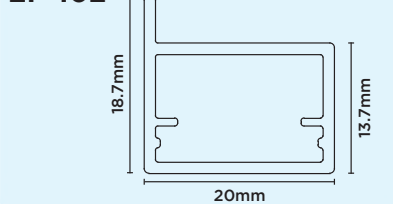
Sr.	Frame Profile	Finish	Ply Thickness	Glass Thickness	HSN Code	GST %	Box Pack
01	<b>EP-09</b> 	Anodized	-	4 - 5 mm	76109030	18%	11
02		SS Brush	-	4 - 5 mm	76109030	18%	11
01	<b>EP-91</b> 	Anodized	-	4 - 5 mm	76109030	18%	11
02		SS Brush	-	4 - 5 mm	76109030	18%	11
01	<b>EGL-016</b> 	Glossy (Mirror)	-	Glass Pasting	76109030	18%	-
		Rose Gold (Glossy)	-	Glass Pasting	76109030	18%	-
02		Grey (Glossy)	-	Glass Pasting	76109030	18%	-
		Black (Matt)	-	Glass Pasting	76109030	18%	-
01	<b>EGL-015</b> 	Glossy (Mirror)	-	Glass Pasting	76109030	18%	-
		Rose Gold (Glossy)	-	Glass Pasting	76109030	18%	-
02		Grey (Glossy)	-	Glass Pasting	76109030	18%	-
		Black (Matt)	-	Glass Pasting	76109030	18%	-
01	<b>EP-101</b> 	Anodized	-	Glass Pasting	76109030	18%	11
02		SS Brush	-	-	-	-	-
01	<b>EP-111</b> 	Anodized	-	Glass Pasting	76109030	18%	11
02		SS Brush	-	-	-	-	-
01	<b>EP-102</b> 	Brush Gold	-	-	76109030	18%	-
02		Rose Gold (Glossy)	-	-	76109030	18%	-
03		Black Matt	-	-	76109030	18%	-

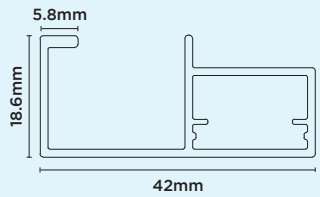
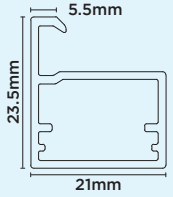
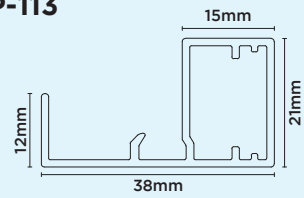
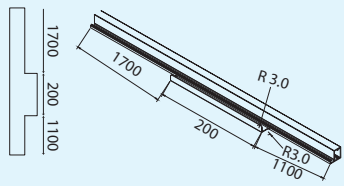
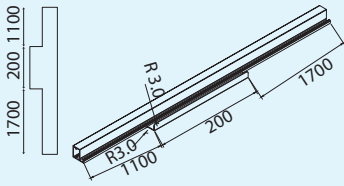
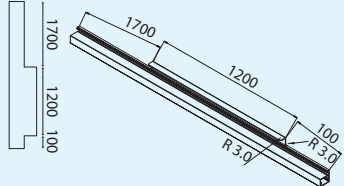
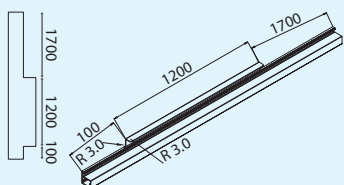
Sr.	Frame Profile	Finish	Ply Thickness	Glass Thickness	HSN Code	GST %	Box Pack
01	<b>EP-112</b> 	Brush Gold	-	-	76109030	18%	-
02		Rose Gold (Glossy)	-	-	76109030	18%	-
03		Black Matt	-	-	76109030	18%	-
01	<b>EP-103</b> 	Brush Gold	-	-	76109030	18%	-
02		Rose Gold (Glossy)	-	-	76109030	18%	-
03		Black Matt	-	-	76109030	18%	-
01	<b>EP-113</b> 	Brush Gold	-	-	76109030	18%	-
02		Rose Gold (Glossy)	-	-	76109030	18%	-
03		Black Matt	-	-	76109030	18%	-
01	<b>AP-133-A-200 Left</b> 	Brush Gold	-	-	76109030	18%	-
02		Rose Gold (Glossy)	-	-	76109030	18%	-
03		Black Matt	-	-	76109030	18%	-
01	<b>AP-133-A-200 Right</b> 	Brush Gold	-	-	76109030	18%	-
02		Rose Gold (Glossy)	-	-	76109030	18%	-
03		Black Matt	-	-	76109030	18%	-
01	<b>AP-133-A-1200 Left</b> 	Brush Gold	-	-	76109030	18%	-
02		Rose Gold (Glossy)	-	-	76109030	18%	-
03		Black Matt	-	-	76109030	18%	-
01	<b>AP-133-A-1200 Right</b> 	Brush Gold	-	-	76109030	18%	-
02		Rose Gold (Glossy)	-	-	76109030	18%	-
03		Black Matt	-	-	76109030	18%	-

# M.R.P. Price List

01st August 2024

# Aluminium

Edge Profile

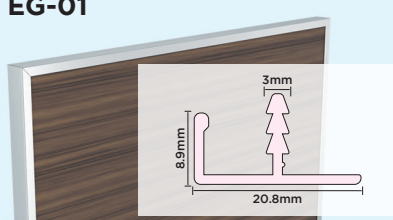
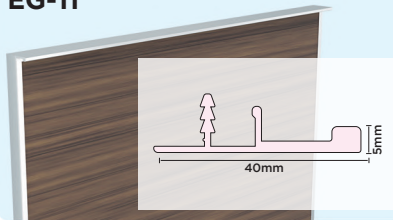
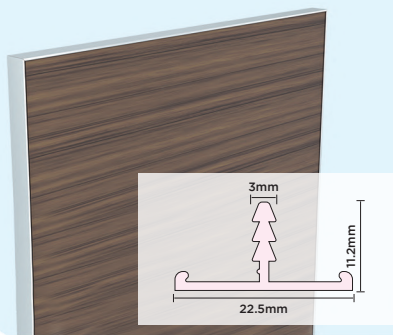
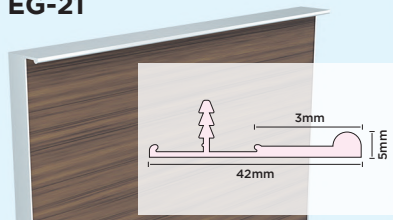
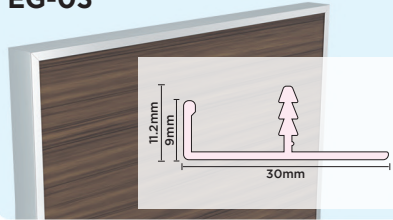
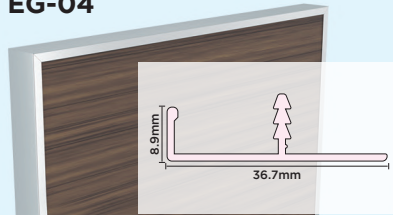
Sr.	Edge Profile	Finish	Ply Thickness	Glass Thickness	HSN Code	GST %	Box Pack
01	<b>EG-01</b> 	Anodized	19 mm	-	76109030	18%	22
02		SS Brush	19 mm	-	76109030	18%	22
01	<b>EG-11</b> 	Anodized	19 mm	-	76109030	18%	22
02		SS Brush	19 mm	-	-	-	-
01	<b>EG-02</b> 	Anodized	19 mm	-	76109030	18%	22
02		SS Brush	19 mm	-	76109030	18%	22
03		Champagne Brush	19 mm	-	76109030	18%	22
04		Rose Gold (Glossy)	19 mm	-	76109030	18%	22
05		Grey (Glossy)	19 mm	-	76109030	18%	22
06		Black (Matt)	19 mm	-	76109030	18%	22
01	<b>EG-21</b> 	Anodized	19 mm	-	76109030	18%	22
02		SS Brush	19 mm	-	-	*	-
01	<b>EG-03</b> 	Anodized	28 mm	-	76109030	18%	22
02		SS Brush	28 mm	-	-	*	-
01	<b>EG-04</b> 	Anodized	35 mm	-	76109030	18%	22
02		SS Brush	35 mm	-	-	*	-



# Aluminium

## Edge Profile

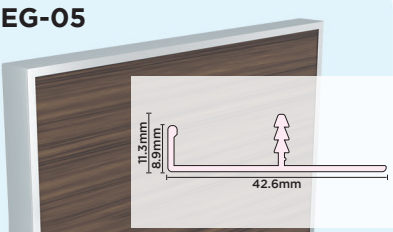
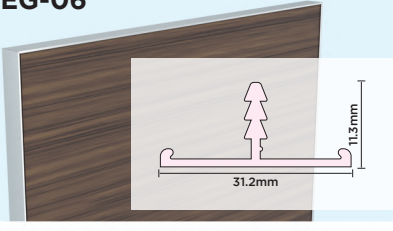
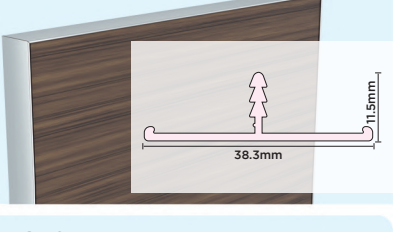
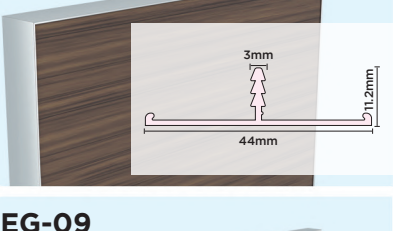
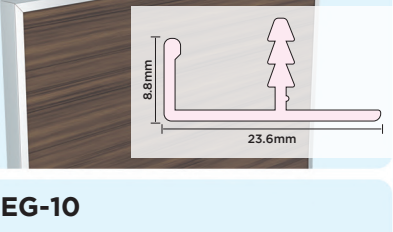
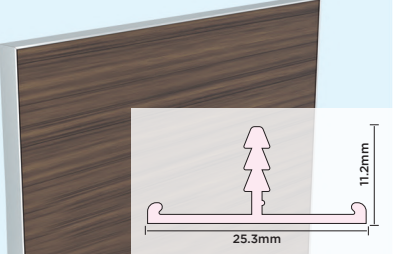
Sr.	Edge Profile	Finish	Ply Thickness	Glass Thickness	HSN Code	GST %	Box Pack
01	<b>EG-05</b> 	Anodized	41 mm	-	76109030	18%	22
02		SS Brush	41 mm	-	-	*	-
01	<b>EG-06</b> 	Anodized	28 mm	-	76109030	18%	22
02		SS Brush	28 mm	-	-	*	-
01	<b>EG-07</b> 	Anodized	35 mm	-	76109030	18%	22
02		SS Brush	35 mm	-	-	-	-
01	<b>EG-08</b> 	Anodized	41 mm	-	76109030	18%	22
02		SS Brush	41 mm	-	-	-	-
01	<b>EG-09</b> 	Anodized	22 mm	-	76109030	18%	22
02		SS Brush	22 mm	-	76109030	18%	22
01	<b>EG-10</b> 	Anodized	22 mm	-	76109030	18%	22
02		SS Brush	22 mm	-	76109030	18%	22
03		Champagne Brush	22 mm	-	76109030	18%	22
04		Rose Gold (Glossy)	22 mm	-	76109030	18%	22
05		Grey (Glossy)	22 mm	-	76109030	18%	22
06		Black (Matt)	22 mm	-	76109030	18%	22

## M.R.P. Price List

01<sup>st</sup> August 2024

# Aluminium

## Edge Profile

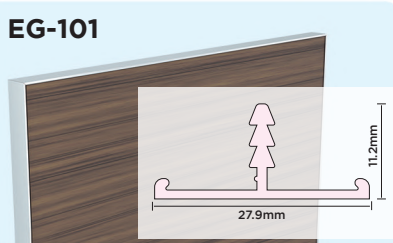
Sr.	Edge Profile	Finish	Ply Thickness	Glass Thickness	HSN Code	GST %	Box Pack
01	<b>EG-101</b> 	Anodized	24.5 mm	-	76109030	18%	22
02		SS Brush	24.5 mm	-	76109030	18%	22

# Aluminium

## Gola Profile

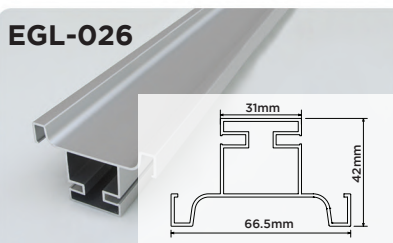
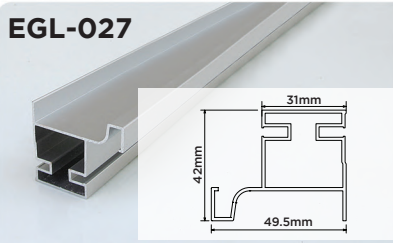
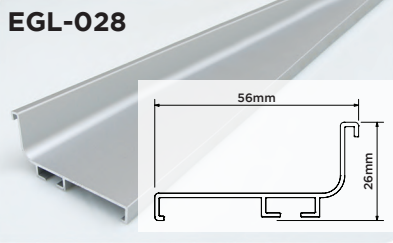
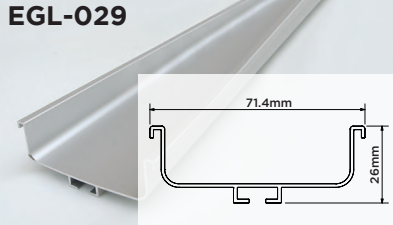
Sr.	Gola Profile	Finish	Description	HSN Code	GST %	Box Pack
01	<b>EGL-026</b> 	Anodized Silver	Center Gola Profile	76109030	18%	10
02		Glossy (Mirror)	Center Gola Profile	76109030	18%	10
01	<b>EGL-027</b> 	Anodized Silver	Top Gola Profile	76109030	18%	10
02		Glossy (Mirror)	Top Gola Profile	76109030	18%	10
01	<b>EGL-028</b> 	Anodized Silver	Top Gola Profile	76109030	18%	10
02		Glossy (Mirror)	Top Gola Profile	76109030	18%	10
03		Rose Gold (Glossy)	Top Gola Profile	76109030	18%	10
04		Black (Matt)	Top Gola Profile	76109030	18%	10
01	<b>EGL-029</b> 	Anodized Silver	Center Gola Profile	76109030	18%	10
02		Glossy (Mirror)	Center Gola Profile	76109030	18%	10
03		Rose Gold (Glossy)	Center Gola Profile	76109030	18%	10
04		Black (Matt)	Center Gola Profile	76109030	18%	10

Sr.	Gola Profile	Finish	Description	HSN Code	GST %	Box Pack
01	<b>EGL-196</b> 	Anodized Silver	For Wall Cabinet with Plastic Grip	76109030	18%	10

## Aluminium Decorative Profile

Sr.	Gola Profile	Finish	Description	HSN Code	GST %	Box Pack
01	<b>EDC-01</b> 	Glossy (Mirror)	6 mm (Heavy)	76109030	18%	150
02	<b>EDC-02</b> 	Glossy (Mirror)	8 mm (Heavy)	76109030	18%	100
03	<b>EDC-03</b> 	Glossy (Mirror)	12 mm (Heavy)	76109030	18%	100

## M.R.P. Price List

01st August 2024

# Aluminium

## Gola Profile

Sr.	Gola Profile	Finish	Description	HSN Code	GST %	Box Pack
04	<p>EDC-011</p>	Glossy (Mirror)	6 mm (Light)	76109030	18%	200
		Champagne Brush	6 mm (Light)	76109030	18%	200
		Rose Gold (Glossy)	6 mm (Light)	76109030	18%	200
		Grey (Glossy)	6 mm (Light)	76109030	18%	200
		Black (Matt)	6 mm (Light)	76109030	18%	200
05	<p>EDC-012</p>	Glossy (Mirror)	8 mm (Light)	76109030	18%	200
		Champagne Brush	8 mm (Light)	76109030	18%	200
		Rose Gold (Glossy)	8 mm (Light)	76109030	18%	200
		Grey (Glossy)	8 mm (Light)	76109030	18%	200
		Black (Matt)	8 mm (Light)	76109030	18%	200
06	<p>EDC-013</p>	Glossy (Mirror)	12 mm (Light)	76109030	18%	150
		Champagne Brush	12 mm (Light)	76109030	18%	150
		Rose Gold (Glossy)	12 mm (Light)	76109030	18%	150
		Grey (Glossy)	12 mm (Light)	76109030	18%	150
		Black (Matt)	12 mm (Light)	76109030	18%	150

# Aluminium

## Handle Profile

Sr.	Handle Profile	Finish	Ply Thickness	Glass Thickness	HSN Code	GST %	Box Pack
01	<p>ED-01</p>	Anodized	19 mm	-	76109030	18%	11
02		SS Brush	19 mm	-	76109030	18%	11
01	<p>ED-02</p>	Anodized	19 mm	-	76109030	18%	11
02		SS Brush	19 mm	-	-	-	-
01	<p>ED-03</p>	Anodized	21 mm	-	76109030	18%	11
02		SS Brush	21 mm	-	-	-	-

# Aluminium Handle Profile

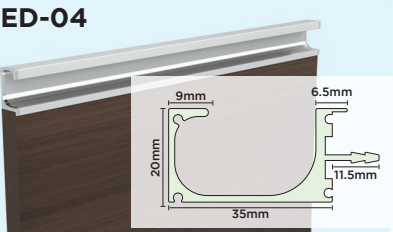
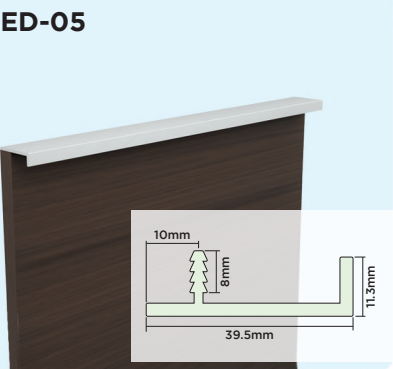
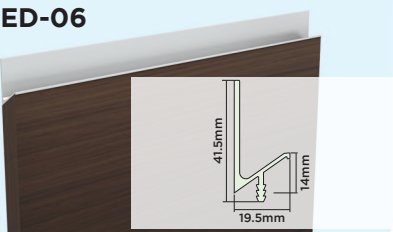
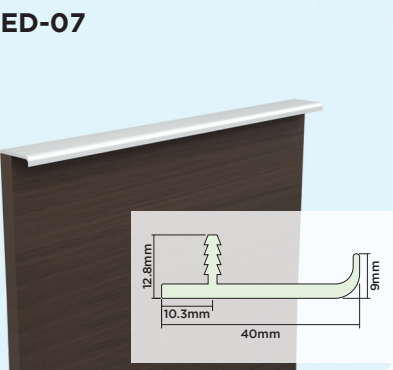
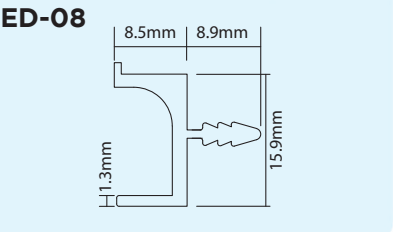
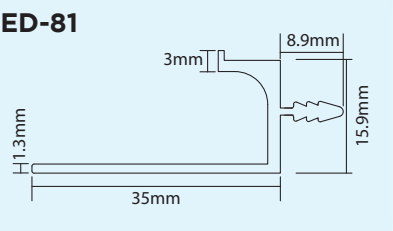
Sr.	Handle Profile	Finish	Ply Thickness	Glass Thickness	HSN Code	GST %	Box Pack
01		Anodized	19 mm	-	76109030	18%	11
02		SS Brush	19 mm	-	-	-	-
01		Anodized	19 mm	-	76109030	18%	11
02		SS Brush	19 mm	-	-	-	-
03		Champagne Brush	19 mm	-	76109030	18%	11
04		Rose Gold (Glossy)	19 mm	-	76109030	18%	11
05		Grey (Glossy)	19 mm	-	76109030	18%	11
06		Black (Matt)	19 mm	-	76109030	18%	11
01		Anodized	19 mm	-	76109030	18%	11
02		SS Brush	19 mm	-	-	-	-
01		Anodized	19 mm	-	76109030	18%	11
02		SS Brush	19 mm	-	-	-	-
03		Champagne Brush	19 mm	-	76109030	18%	11
04		Rose Gold (Glossy)	19 mm	-	76109030	18%	11
05		Grey (Glossy)	19 mm	-	76109030	18%	11
06		Black (Matt)	19 mm	-	76109030	18%	11
01		Brush Gold	-	-	76109030	18%	-
02		Rose Gold (Glossy)	-	-	76109030	18%	-
02		Black Matt	-	-	76109030	18%	-
01		Brush Gold	-	-	76109030	18%	-
02		Rose Gold (Glossy)	-	-	76109030	18%	-
02		Black Matt	-	-	76109030	18%	-

# M.R.P. Price List

01<sup>st</sup> August 2024

# Aluminium

Frame Profile

Sr.	Frame Profile	Finish	Ply Thickness	Glass Thickness	HSN Code	GST %	Box Pack
01		Anodized	19 mm	-	76109030	18%	11
02		SS Brush	19 mm	-	76109030	18%	11
03		Champagne Brush	19 mm	-	76109030	18%	11
04		Rose Gold (Glossy)	19 mm	-	76109030	18%	11
05		Grey (Glossy)	19 mm	-	76109030	18%	11
06		Black (Matt)	19 mm	-	76109030	18%	11

Sr.	Frame Profile	Finish	Ply Thickness	Glass Thickness	HSN Code	GST %	Box Pack
01		Anodized	-	4 - 5 mm	76109030	18%	11
02		SS Brush	-	4 - 5 mm	76109030	18%	11
03		Champagne Brush	-	4 - 5 mm	76109030	18%	11
04		Rose Gold (Glossy)	-	4 - 5 mm	76109030	18%	11
05		Grey (Glossy)	-	4 - 5 mm	76109030	18%	11
06		Black (Matt)	-	4 - 5 mm	76109030	18%	11

Sr.	Frame Profile	Finish	Ply Thickness	Glass Thickness	HSN Code	GST %	Box Pack
01		Anodized	-	4 - 5 mm	76109030	18%	11
02		SS Brush	-	4 - 5 mm	76109030	18%	11
03		Champagne Brush	-	4 - 5 mm	76109030	18%	11
04		Rose Gold (Glossy)	-	4 - 5 mm	76109030	18%	11
05		Grey (Glossy)	-	4 - 5 mm	76109030	18%	11
06		Black (Matt)	-	4 - 5 mm	76109030	18%	11

Sr.	Frame Profile	Finish	Ply Thickness	Glass Thickness	HSN Code	GST %	Box Pack
01		Anodized	-	4 - 5 mm	76109030	18%	11
02		SS Brush	-	4 - 5 mm	76109030	18%	11
03		Champagne Brush	-	4 - 5 mm	76109030	18%	11
04		Rose Gold (Glossy)	-	4 - 5 mm	76109030	18%	11
05		Grey (Glossy)	-	4 - 5 mm	76109030	18%	11
06		Black (Matt)	-	4 - 5 mm	76109030	18%	11

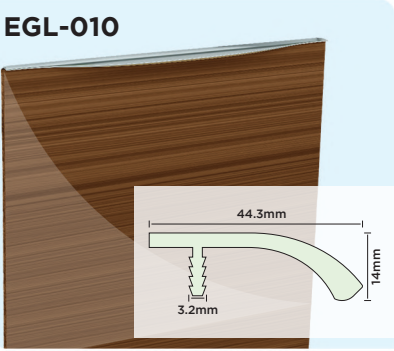
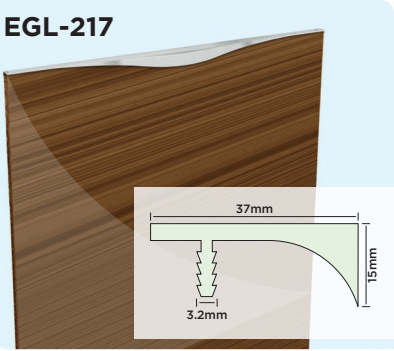
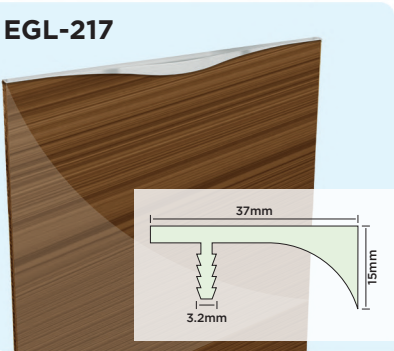
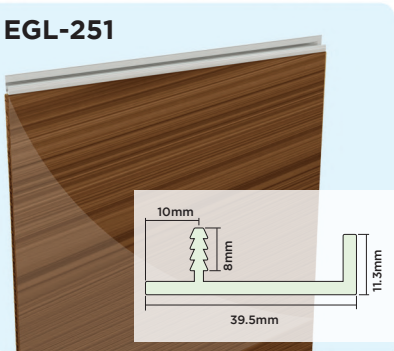
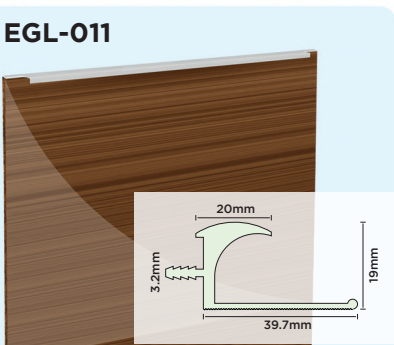



Sr.	Handle Profile	Finish	Ply Thickness	Glass Thickness	HSN Code	GST %	Box Pack
01 02 03 04 05 06 07 08	<b>EGL-010</b> 	SS Brush	19mm	297 mm 317 mm 347 mm 397 mm 447 mm 497 mm 597 mm 897 mm	76169990	18%	-
01 02 03 04 05 06 07 08 09	<b>EGL-217</b> 	SS Brush	19mm	297 mm 317 mm 347 mm 397 mm 447 mm 497 mm 597 mm 697mm 897 mm	76169990	18%	-
01 02 03 04 05 06 07 08 09	<b>EGL-217</b> 	CP Finish	19mm	297 mm 317 mm 347 mm 397 mm 447 mm 497 mm 597 mm 697mm 897 mm	76169990	18%	-
01 02 03 04 05 06 07 08	<b>EGL-251</b> 	SS Brush	19mm	297 mm 317 mm 347 mm 397 mm 447 mm 497 mm 597 mm 897 mm	76169990	18%	-
01 02 03 04 05 06 07 08	<b>EGL-011</b> 	Bright Silver	19mm	297 mm 317 mm 347 mm 397 mm 447 mm 497 mm 597 mm 897 mm	76169990	18%	-

**M.R.P. Price List**

01<sup>st</sup> August 2024

# Aluminium

Handle Profile

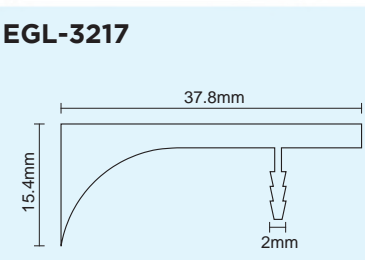
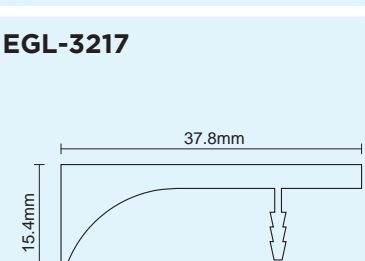
Sr.	Handle Profile	Finish	Size	HSN Code	GST %	Box Pack				
01 02 03 04 05 06 07	<b>EGL-3125</b> 	Matt Black	247 mm 297 mm 397 mm 447 mm 497 mm 597 mm 897 mm	76169990	18%	-				
01 02 03 04 05 06 07	<b>EGL-3125</b> 		247 mm 297 mm 397 mm 447 mm 497 mm 597 mm 897 mm							
01 02 03 04 05 06 07	<b>EGL-3216</b> 		247 mm 297 mm 397 mm 447 mm 497 mm 597 mm 897 mm							
01 02 03 04 05 06 07	<b>EGL-3216</b> 		247 mm 297 mm 397 mm 447 mm 497 mm 597 mm 897 mm							
01 02 03 04 05 06 07	<b>EGL-3217</b> 		SS Brush				247 mm 297 mm 397 mm 447 mm 497 mm 597 mm 897 mm	76169990	18%	-
01 02 03 04 05 06 07	<b>EGL-3217</b> 		CP Finish				247 mm 297 mm 397 mm 447 mm 497 mm 597 mm 897 mm	76169990	18%	-



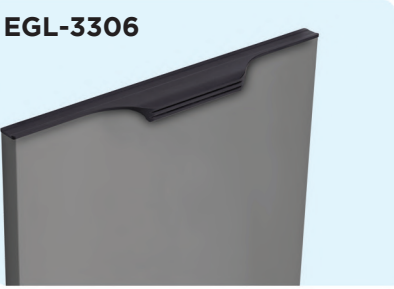
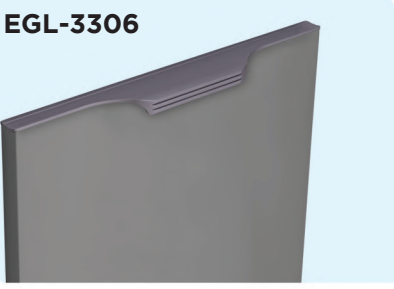
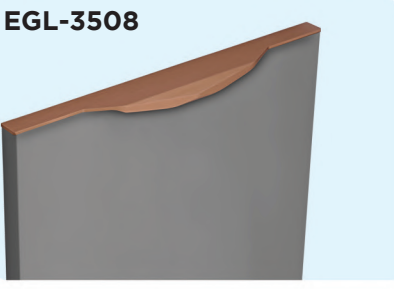
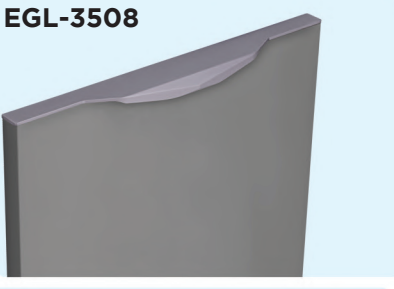
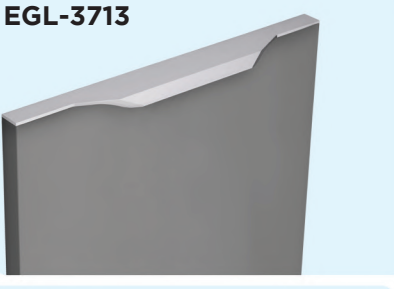
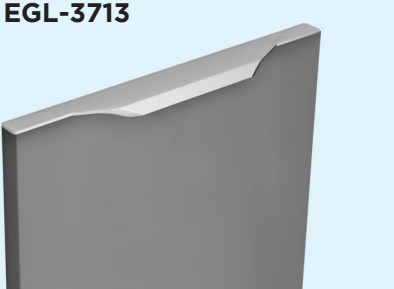



Sr.	Handle Profile	Finish	Size	HSN Code	GST %	Box Pack
01 02 03 04 05 06 07	<b>EGL-3306</b> 	Matt Black	247 mm 297 mm 397 mm 447 mm 497 mm 597 mm 897 mm	76169990	18%	-
01 02 03 04 05 06 07	<b>EGL-3306</b> 	Matt Grey	247 mm 297 mm 397 mm 447 mm 497 mm 597 mm 897 mm	76169990	18%	-
01 02 03 04 05 06 07	<b>EGL-3508</b> 	Brushed Bronze	247 mm 297 mm 397 mm 447 mm 497 mm 597 mm 897 mm	76169990	18%	-
01 02 03 04 05 06 07	<b>EGL-3508</b> 	Matt Grey	247 mm 297 mm 397 mm 447 mm 497 mm 597 mm 897 mm	76169990	18%	-
01 02 03 04 05 06 07	<b>EGL-3713</b> 	SS Brush	247 mm 297 mm 397 mm 447 mm 497 mm 597 mm 897 mm	76169990	18%	-
01 02 03 04 05 06 07	<b>EGL-3713</b> 	CP Finish	247 mm 297 mm 397 mm 447 mm 497 mm 597 mm 897 mm	76169990	18%	-

# M.R.P. Price List

01<sup>st</sup> August 2024

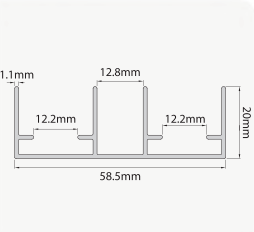
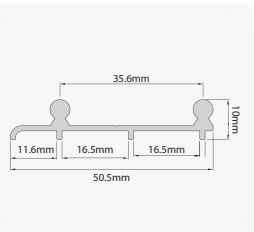
## Door Sliding System

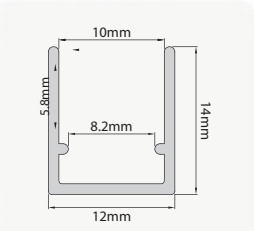
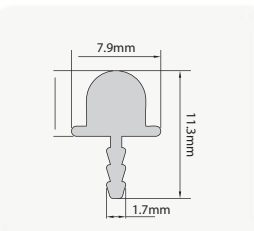



Sr.	Wardrobe Sliding Fitting	Code No.	Finish	Length	Description	HSN Code	GST %	Box Pack
01		WSF-03	Black	-	(Distributed In Set) Related Profile: WSP-01 & WSP-11	83024200	18%	48
02		WSF-03 Soft Close	Black	-	(Distributed In Set) Related Profile: WSP-01 & WSP-11	83024200	18%	48
03		WSP-01	Anodise	6 Feet 8 Feet 10 Feet	Top Profile For: WSF-03	76109020	18%	9
04		WSP-11	Anodise	6 Feet 8 Feet 10 Feet	Bottom Profile For: WSF-03	76109020	18%	9
05		WSF-01	Black	-	(Distributed In Set) Related Profile: WSP-02 & WSP-21	83024200	18%	48
06		WSP-02	Anodise	6 Feet 8 Feet 10 Feet	Top Profile For: WSF-01	76109020	18%	30
07		WSP-21	Anodise	6 Feet 8 Feet 10 Feet	Bottom Profile For: WSF-01	76109020	18%	30

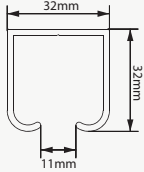

Sr.	Wardrobe Sliding Fitting	Code No.	Finish	Length	Description	HSN Code	GST %	Box Pack
08		WSF-02	Zinc	-	(Distributed In Set) Related Profile: WSP-03	83024200	18%	48
09		WSP-03	Anodise	6 Feet 8 Feet 10 Feet	Top & Bottom Profile For: WSF-02	76109020	18%	60
10		WSF-04 2 Door	Zinc	-	[Distributed In Set] Related Profile: Top Profile WSP-06 & Bottom Profile WSP-21	83024200	18%	-
11		WSF-04 3 Door	Zinc	-	(Distributed In Set) Related Profile: Top Profile WSP-06 & Bottom Profile WSP-21	83024200	18%	-
12		WSP-06	Anodise	10 Feet	Top & Bottom Profile: WSP-04-2 Door WSP-04-3 Door	76109020	18%	-
13		DSF-01	Mat	-	Four Wheel Roller (Distributed In Set)	83024200	18%	-
14		DSF-02	Mat	-	Eight Wheel Roller (Distributed In Set)	83024200	18%	-

# M.R.P. Price List

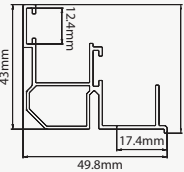
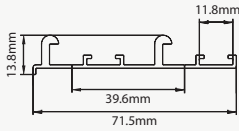
01st August 2024

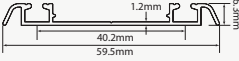
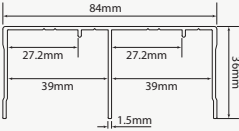
## Door Sliding System

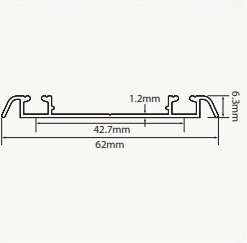
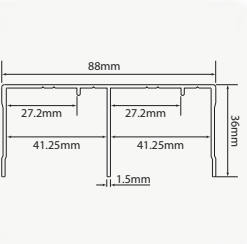

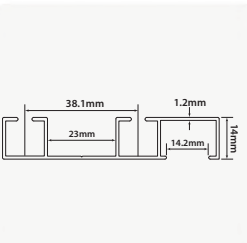
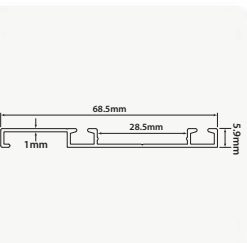
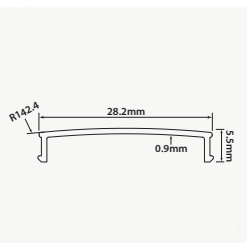
Sr.	Wardrobe Sliding Fitting	Code No.	Finish	Length	Description	HSN Code	GST %	Box Pack
15		WSP-04	Anodise	8 Feet 10 Feet 12 Feet	Top Profile For: DSF-01 & DSF-02	76109020	18%	9
16		WSF-05 2 Door WSF-05 3 Door	Zinc	- -	Related Profile Top Profile WSP-08 Bottom Profile WSP-07	83024200	18%	-
17		WSP-07	Zinc	10 Feet	Bottom Profile WSF-05-2 Door WSF-05-3 Door	76109020	18%	-
18		WSP-08	Zinc	10 Feet	Top Profile WSF-05-2 Door WSF-05-3 Door	76109020	18%	-
19		WSF-06 2 Door WSF-06 3 Door	Zinc	-	Related Profile Top Profile WSP-09 Bottom Profile WSP-09 Thickness of Door 16mm to 19mm	83024200	18%	48
20		WSP-09	Silver	8 Feet 13 Feet	Bottom Profile For WSF-06	76109020	18%	9
21		WSP-09	Silver	8 Feet 13 Feet	Top Profile For WSF-06	76109020	18%	9



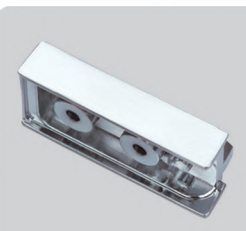
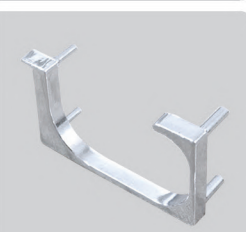

Sr.	Wardrobe Sliding Fitting	Code No.	Finish	Length	Description	HSN Code	GST %	Box Pack
22		WSF-07 2 Door WSF-07 3 Door	Zinc	-	Related Profile Top Profile WSP-10 Bottom Profile WSP-10 Thickness of Door 20mm to 24mm	83024200	18%	48
23		WSP-10	Silver	8 Feet 13 Feet	Bottom Profile For WSF-07 2-Door 3-Door	76109020	18%	30
24		WSP-10	Silver	8 Feet 13 Feet	Top Profile For WSF-07 2-Door 3-Door	76109020	18%	30
25		WSF-08 2 Door WSF-08 3 Door	Zinc	-	(Distributed In Set) Related Profile Top Profile WSP-12 Bottom Profile WSP-12, 12C	83024200	18%	15
26		WSP-12	Silver	8 Feet 13 Feet	Top Profile For WSF-08 WSF-04	76109020	18%	60
27		WSP-12	Silver	8 Feet 13 Feet	Bottom Profile For WSF-08 WSF-04	76109020	18%	60
28		WSP-12C	Silver	8 Feet 13 Feet	Bottom Cover Profile For WSF-08 WSF-04	76109020	18%	60

## M.R.P. Price List

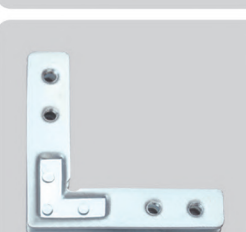
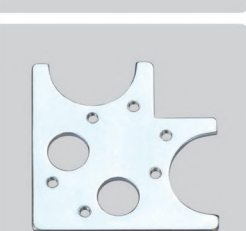
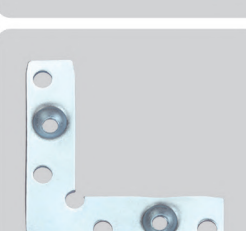
01<sup>st</sup> August 2024

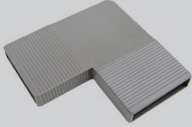
# Door Sliding System

Sr.	Product	Code No.	Finish	Description	HSN Code	GST %	Box Pack
01		EDEB03	Anodized	Suitable For ED - 03	83024200	18%	50
02		EDEB02	Anodized	Suitable For ED - 02	83024200	18%	50
03		EDEB04	Mirror	Suitable For ED - 04	39269099	18%	-
04		EPCA01	Big	Suitable For EP - 01, 02, 04 05, 06, 07	83024200	18%	50
05		EPCA02	-	Suitable For EP - 03, 31, 32	83024200	18%	50
06		EPCA03	-	Suitable For EP - 08, 09	83024200	18%	50
07		EPCA01-S	Small	Suitable For EP - 01, 02, 04 05, 06, 07	83024200	18%	50

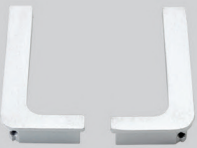
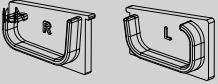
Sr.	Product	Code No.	Finish	Description	HSN Code	GST %	Box Pack
08		PVC L Clamp 4 Pcs=1 Set	Grey	Suitable For EGL - 015, 016	39269010	18%	-
09		L Clamp 90° Corner	Zinc	Suitable For EGL - 028, 029	83024200	18%	50
10		EGL-028-I Corner	Matt	Suitable For EGL - 028	79070090	18%	-
11		EGL028-O Corner	Matt	Suitable For EGL - 028	79070090	18%	50
12		EGL- 029 End Cap	Matt	Suitable For EGL - 029	79070090	18%	-
			Glossy	Suitable For EGL - 029	79070090	18%	-
13		EGL-028 End Cap	Matt	Suitable For EGL - 028	79070090	18%	-
			Glossy	Suitable For EGL - 028	79070090	18%	-
14		ADEB 01-L	Anodized SS Brush Champagne Brush Chrome Finish (For Rose Gold) Chrome Finish (For Grey)	Suitable For AD - 01	83024200	18%	-



# **BATHROOM ACCESSORIES**



GST - 18 % | HSN CODE - 73269099

## Accessory Shelf - 1 Layer



### Size (WxDxH) mm

300 x 113 x 140  
375 x 113 x 140  
450 x 113 x 140

### Box Pack

24  
20  
20

## Accessory Shelf - 2 Layers



### Size (WxDxH) mm

300 x 113 x 360

### Box Pack

10

## Accessory Shelf - 3 Layers



### Size (WxDxH) mm

300 x 113 x 530

### Box Pack

10

## Corner Shelf - 1 Layer



### Size (WxDxH) mm

225 x 225 x 140  
300 x 300 x 140

### Box Pack

20  
16

## Corner Shelf - 2 Layers



### Size (WxDxH) mm

300 x 300 x 360

### Box Pack

4

**M.R.P. Price List**  
01<sup>st</sup> August 2024

**GST - 18 % | HSN CODE - 73269099**

<p><b>Corner Shelf - 3 Layers</b></p>	<p><b>Size (WxDxH) mm</b></p>	<p><b>Box Pack</b></p>
	<p>300 x 300 x 530</p>	<p>4</p>
<p><b>Towel Rack</b></p>	<p><b>Size (WxDxH) mm</b></p>	<p><b>Box Pack</b></p>
	<p>450 x 250 600 x 250</p>	<p>8 8</p>
<p><b>Towel Rail</b></p>	<p><b>Size (WxDxH) mm</b></p>	<p><b>Box Pack</b></p>
	<p>300 x 100 x 100 450 x 100 x 100 600 x 100 x 100</p>	<p>24 20 20</p>
<p><b>Hand Towel Holder</b></p>	<p><b>Size (WxDxH) mm</b></p>	<p><b>Box Pack</b></p>
	<p>220 x 80 x 140</p>	<p>20</p>
<p><b>Clothes Hook - 3 Hook</b></p>	<p><b>Size (WxDxH) mm</b></p>	<p><b>Box Pack</b></p>
	<p>150 x 250</p>	<p>40</p>

GST - 18 % | HSN CODE - 73269099

## Clothes Hook - 4 Hook



Size (WxDxH) mm

Box Pack

150 x 450

40

## Soap & Shampoo Holder



Size (WxDxH) mm

Box Pack

300 x 130 x 160

24

## Tissue Roll & Mobile Holder



Size (WxDxH) mm

Box Pack

225 x 120 x 110

24

## Tooth Brush Holder



Size (WxDxH) mm

Box Pack

170 x 100 x 140

30

## Toilet Brush / Broom Holder



Size (WxDxH) mm

Box Pack

220 x 80 x 140

10



**Evershine<sup>®</sup>**

**CRYSTAL INTERIOR PRODUCTS PVT. LTD.**

Plot No. 41, Ichhapore G.I.D.C., Opp. ONGC,  
Sachin-Hazira Road, Bhatpore Village, Surat - 394510 (Guj.) INDIA.

Email : [info@evershinecrystal.in](mailto:info@evershinecrystal.in) | Web : [www.evershinecrystal.in](http://www.evershinecrystal.in)